

# AXL E IOL AI1 U M12 S

**Axioline E IO-Link/analog converter  
for connecting an analog sensor,  
0 V ... 10 V, straight version**

Data sheet  
8593\_en\_09

© PHOENIX CONTACT 2020-06-30



## 1 Description

The IO-Link/analog converter is an IO-Link device that converts analog signals into the IO-Link protocol.

It therefore offers the option of acquiring the signals of analog sensors via an IO-Link master.

### IO-Link features

- Connection to an IO-Link master with M12 connector (A-coded, 4-pin)
- IO-Link A port
- IO-Link specification V1.1.1

### General Features

- Straight version
- 1 IO-Link interface
- 1 analog input
- Connection of the sensor in 3-wire technology via an M12 connector (A-coded, 5-pin)
- Voltage range: 0 V ... 10 V
- FE connection for local connection to functional earth ground
- Supply of the module electronics and the sensor via the IO-Link interface of the IO-Link master
- Local status indicator
- Degree of protection IP65/67



Make sure you always use the latest documentation.  
It can be downloaded from the product at [phoenixcontact.net/products](https://phoenixcontact.net/products).



<b>2</b>	<b>Table of contents</b>	
1	Description .....	1
2	Table of contents .....	2
3	Ordering data .....	3
4	Technical data .....	3
5	Additional tables .....	5
6	Internal circuit diagram .....	5
7	Pin assignment .....	6
7.1	Connections on the device .....	6
7.2	Pin assignment of the IO-Link interface .....	6
7.3	Pin assignment of the analog input .....	6
8	Connection notes .....	6
9	Connection example .....	6
10	Assembly .....	7
11	Local status indicator .....	7
12	Process data .....	8
12.1	IN process data .....	8
12.2	OUT process data .....	9
12.3	Parameterization via OUT process data .....	9
12.4	Example .....	9
13	Significant values in various formats .....	10
13.1	IB IL format .....	10
13.2	Format S7 compatible .....	10
14	IO-Link objects .....	11
14.1	Overview of the objects .....	11
14.2	Parameterization (80 <sub>hex</sub> : ParaWord) .....	12

### 3 Ordering data

Description	Type	Order No.	Pcs./Pkt.
Axioline E-IO-Link/analog converter for connecting an analog sensor, 0 V ... 10 V, M12 fast connection technology, straight version	AXL E IOL AI1 U M12 S	2700336	1

### 4 Technical data

#### Dimensions (nominal sizes in mm)

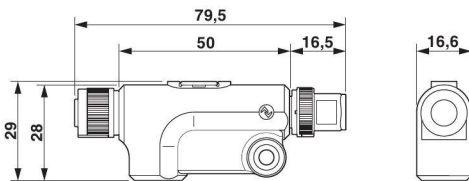

Width	16.6 mm
Height	29 mm
Depth	79.5 mm

#### General data

Weight	34 g
Ambient temperature (operation)	-25 °C ... 60 °C
Ambient temperature (storage/transport)	-25 °C ... 85 °C
Permissible humidity (operation)	5 % ... 95 %
Permissible humidity (storage/transport)	5 % ... 95 %
Air pressure (operation)	70 kPa ... 106 kPa (up to 3000 m above sea level)
Air pressure (storage/transport)	70 kPa ... 106 kPa (up to 3000 m above sea level)
Degree of protection	IP65/67
Protection class	III, IEC 61140, EN 61140, VDE 0140-1
Degree of pollution	2

#### IO-Link

Specification	V1.1.1
Reverse polarity protection	Yes
Transmission speed	230,4 kBit/s (COM3)
Frame type	1
Cycle Time	min. 2 ms
Process data update	2 ms
Amount of process data	16 Bit (Input data), 16 Bit (Output data)

**IO-Link ports**

Number of ports	1
Connection method	M12 connector, A-coded

**IO-Link port supply**

Nominal voltage for I/O supply	24 V DC (This supply voltage is provided via the IO-Link interface of the IO-Link master.)
Sensor supply voltage	24 V DC (This supply voltage is provided via the I/O supply.)
Current consumption	typ. 16.5 mA ±15 % (at 24 V DC), max. 120 mA
Nominal current	max. 100 mA
Reverse polarity protection	yes
Short-circuit protection	yes
Overload protection	yes

**Analog input**

Number of inputs	1 (voltage)
Connection method	M12 connector, A-coded
Connection method	3-wire (optionally 4-wire)
Voltage input signal	0 V ... 10 V
Input resistance of voltage input	min. 100 kΩ
Resolution A/D	12 bit
Data formats	IB IL, S7-compatible
Filtering	None or mean-value generation over 4, 16, or 32 measured values
Precision	< 0.25 % (Of the measuring range final value in the nominal range)
Permissible cable length	max. 30 m (Shielded cable)

**Error messages to the higher level control or computer system**

Overrange or underrange	Message in the diagnostic code (in the IB IL format)
Measured value invalid/no valid measured value present	Message in the diagnostic code (in the IB IL format)
Module faulty	Message in the diagnostic code (in the IB IL format)

**Mechanical tests**

Vibration resistance according to EN 60068-2-6/IEC 60068-2-6	Operation: 2g
Vibration resistance according to EN 60068-2-6/IEC 60068-2-6	Storage/transport: 5g
Shock according to EN 60068-2-27/IEC 60068-2-27	Operation: 30g, 11 ms, three shocks in each space direction
Shock according to EN 60068-2-27/IEC 60068-2-27	Storage/transport: 50g, 11 ms, three shocks in each space direction
Continuous shock according to EN 60068-2-27/IEC 60068-2-27	10g, 16 ms, 1000 shocks, in all space directions

**Approvals**

For the latest approvals, please visit [phoenixcontact.net/products](http://phoenixcontact.net/products).

## 5 Additional tables

The data is valid for nominal operation (supply voltage = 24 V) in the default configuration (measuring range 0 V ... 10 V).

Tolerance and temperature response at $T_A = -25^\circ\text{C}$ to $+60^\circ\text{C}$	
Drift	
Typical	Maximum
$\pm 45$ ppm/K	$\pm 75$ ppm/K

The tolerance values refer to the measuring range final value.

Tolerances influenced by electromagnetic interference			
Type of electromagnetic interference	Standard	Tolerance	Criterion
Electromagnetic fields	EN 61000-4-3/ IEC 61000-4-3	$< \pm 2.0\%$	A
Fast transients (burst)	EN 61000-4-4/ IEC 61000-4-4	$< \pm 1.0\%$	A
Conducted interference	EN 61000-4-6/ IEC 61000-4-6	$< \pm 0.5\%$	A

## 6 Internal circuit diagram

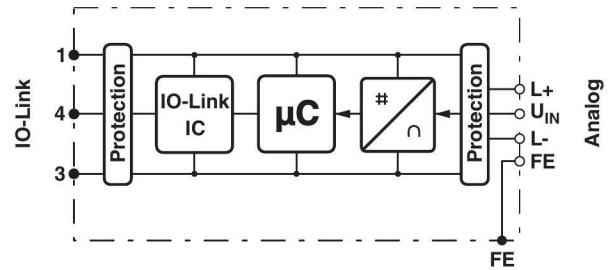
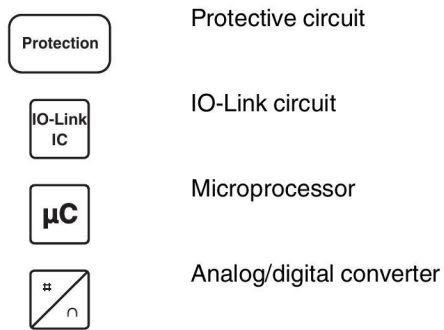

Figure 1 Internal wiring of connections

Key:



## 7 Pin assignment

### 7.1 Connections on the device

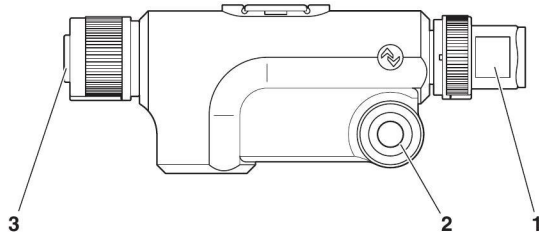

Figure 2 Connections on the converter

No.	Connection
1	IO-Link interface (indicated by IO-Link symbol)
2	Fixing options; options for connection to functional earth ground
3	Analog input

### 7.2 Pin assignment of the IO-Link interface

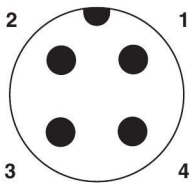

Figure 3 Pin assignment of the I/O link interface (M12 A-coded, pin)

Pin	Signal	Meaning
1	L+	+24 V supply voltage; from IO-Link master
2	-	Not used
3	L-	GND, reference potential for L+
4	C/Q	IO-Link data transmission channel

### 7.3 Pin assignment of the analog input

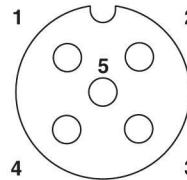

Figure 4 Pin assignment of the analog input (M12 A-coded, socket)

Pin	Assignment
1	+24 V, 100 mA sensor supply
2	Not used
3	GND
4	Voltage input 0 V ... 10 V
5	Not used

## 8 Connection notes

Always connect the analog sensors using shielded, twisted pair cables.

## 9 Connection example

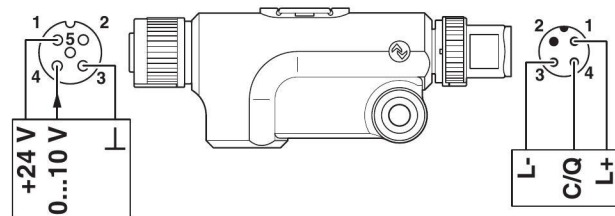

Figure 5 Connection example



## 10 Assembly

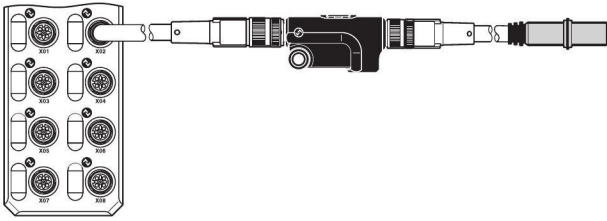

Figure 6 Connection of a sensor to an IO-Link master via the converter

- Connect the IO-Link interface of the converter to an IO-Link port of the higher-level IO-Link master using a standardized 3-pos. cable.
- Connect the analog sensor directly to the analog converter input or using a shielded 4-pos. cable.
- Fasten each connection using the M12 connectors.



In environments with high levels of interference, in particular, Phoenix Contact recommends connecting the converter to an appropriate functional earth ground point using an M4 screw.

## 11 Local status indicator

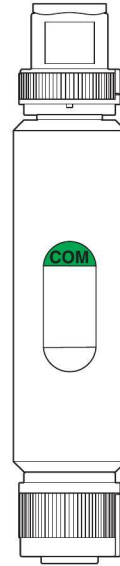

Figure 7 Local status indicator

Designation	Color	Meaning	State	Description
COM	Green	Status of IO-Link device	ON	Supply voltage OK
			Flashing	Supply voltage OK, SDCI communication active
			OFF	No supply voltage, no communication

## 12 Process data

The device occupies one word of IN process data and one word of OUT process data.

### 12.1 IN process data

The measured values are depicted in IB IL or S7-compatible format.

For both formats the measured value is represented in bits 14 to 3. Bit 15 is available as a sign bit. Bits 2 to 0 are not relevant for the measured value.

15	14	13	12	11	10	9	8	7	6	5	4	3	2	1	0
V	Analog value											x	x	x	

- V Sign bit (= 0, not relevant)
- x Not relevant for the measuring range  
(= 0 must be set)

In the event of an error, a diagnostic code is mapped to the input data:

#### IB IL format

The values > 8000<sub>hex</sub> and < 8100<sub>hex</sub> indicate an error.

Code (hex)	Cause
8001	Overrange (overflow)
8002	Wire break
8003	Short-circuit
8004	Measured value invalid or no valid measured value available
8040	Device faulty

#### S7-compatible format

In the S7-compatible format, there are two diagnostic codes, depicted as follows.

Code (hex)	Cause
7FFF	Overrange (overflow)
8000	Wire break



### 12.2 OUT process data

The device can be configured via the process data output word.

The following configurations are possible:

- Selection of formats for representing measured values
- Setting mean-value generation

15	14	13	12	11	10	9	8	7	6	5	4	3	2	1	0
Configuration	Reserved					Filter		Reserved		Format		Reserved			



For the exact meaning of the individual bits, please refer to "Parameterization (80<sub>hex</sub>: ParaWord)".

### 12.3 Parameterization via OUT process data

Reparameterization can be carried out via the output process data, however this is not saved permanently on the device.



Only carry out re-parameterization when starting up the device!

The following sequence applies regardless of the format (IB IL or S7-compatible):

- The master sends parameter data (OutputProcessData with bit 15 = 1)



In order to start configuration, bit 15 of the output word must be set to 1. If bit 15 = 0, the default configuration is active.

- The device interrupts the transmission of current process data and responds with the following diagnostic code in the process data:

Code (hex)	Cause
8800	Parameter OK
8801	Parameter ERROR

- If the diagnostic code is OK, the parameter data is accepted immediately. The master can end parameterization (OutputProcessData with bit 15 = 0). The device returns to normal operation with cyclic process data transmission.
- In the event of the ERROR diagnostic code, the master can abort parameterization without modified parameter data (OutputProcessData with bit 15 = 0) or transmit the modified parameterization (return to step 1).

### 12.4 Example

The example applies for the following changes:

- Switching the formats from S7-compatible (default) to IB IL
- For 16-sample mean-value generation

15	14	13	12	11	10	9	8	7	6	5	4	3	2	1	0
Configuration	Reserved					Filter		Reserved		Format		Reserved			
1	Reserved					1	0	Reserved		1	0	Reserved			

## 13 Significant values in various formats

### 13.1 IB IL format

Resolution: 1 bit (0000 -> 0008) corresponds to 2.67 mV

Input data		0 V ... 10 V
hex	dec	V
8001	Overrange (overflow)	> 10.837
7EF8	32511	10.837
7538	30008	10.00267
7530	30000	10.0
3A98	15000	5.0
0008	8	0.00267
0000	0	0
8002	Wire break	-

### 13.2 Format S7 compatible

Resolution: 1 bit (0000 -> 0008) corresponds to 2.89 mV

Input data		0 V ... 10 V
hex	dec	V
7FFF	Overrange (overflow)	> 11.756
7EF0	32503	11.756
6C08	27656	10.00289
6C00	27648	10.0
3600	13824	5.0
0008	8	0.00289
0000	0	0
8000	Wire break, short-circuit	-

The value 8000<sub>hex</sub> is specified in S7-compatible format for all errors for which diagnostic codes 8001<sub>hex</sub> to 8040<sub>hex</sub> are output in IB IL format.

## 14 IO-Link objects

### 14.1 Overview of the objects

Index (hex)		Index (dec)		Object name	Length in bytes	Access	Meaning	Contents
DPP	ISDU	DPP	ISDU					
<b>Identification</b>								
0007		7		Vendor ID	2	R	Vendor ID	00 <sub>hex</sub>
0008		8						B0 <sub>hex</sub>
0009		9		Device ID	3	R	Device ID	01 <sub>hex</sub>
000A		10						00 <sub>hex</sub>
000B		11						01 <sub>hex</sub>
	0010		16	VendorName	64	R	Vendor name	Phoenix Contact
	0011		17	VendorText	64	R	Notes	phoenixcontact.com
	0012		18	ProductName	64	R	Product name	AXL E IOL AI1 U M12 S
	0013		19	Product ID	64	R	Order No.	2700336
	0014		20	ProductText	64	R	Product text	IO-Link/analog converter voltage input straight
	0015		21	SerialNumber	16	R	Serial number	Stored in the production process.
	0016		22	HardwareVersion	64	R	Hardware version	E.g., 01
	0017		23	FirmwareVersion	64	R	Firmware version	E.g., 001
<b>Diagnostics</b>								
	0020		32	ErrorCount	2	R	Errors since power up	Number of errors
	0028		40	InputProcessData	2	R	Input process data	Last current data
<b>Parameter</b>								
	0080		128	ParaWord	2	R/W	Parameterization	0000 <sub>hex</sub>

Abbreviation	Meaning
R	Read
W	Write

**14.2 Parameterization (80<sub>hex</sub>: ParaWord)**

Parameterize the device using this object.

In the case of valid parameters, the parameterization is permanently stored on the device.

After a reset, the device operates with the last permanently stored data. Upon delivery, the device operates with the default data (default settings).



Saving data to the device leads to a communication failure of around 30 ms.

15	14	13	12	11	10	9	8	7	6	5	4	3	2	1	0
Reserved						Filter		Reserved		Format		Reserved			

In the following tables the values in **bold** are default settings.

Format	
Code (bin)	Meaning
<b>00</b>	<b>S7-compatible</b>
10	IB IL
Other	Reserved

Filter	
Code (bin)	Meaning
<b>00</b>	<b>No filter</b>
01	4-sample mean-value
10	16-sample mean-value
11	32-sample mean-value